



AQUANOVA

BATH ESSENTIALS

CREATED FOR YOUR COMFORT

CATALOGUE 2022.1 SPRING - SUMMER



3 NEW ARRIVALS

BATH

- 1 BATH MATS
- 4 BATH TOWELS
- 2 BATHROBES
- 2 BATH ACCESSORIES
- 2 MIRRORS
- 6 WASTE BINS
- 3 BATH & SHOWER BASICS /
- 0 SCALES
- 8 LAUNDRY BASKETS
- 8 STORAGE BASKETS
- 5 BATHROOM ORGANIZERS
- 4
- 8
- 8

86 PERSONAL CARE

- 86 SOAPS

SUPPORT

- 90 SPARE PARTS
- 96 SALES SUPPORT
- 98 CARE INSTRUCTIONS / FAQ
- 10 DISCONTINUED
- 2 CONTACT / COLOPHON
- 10
- 4



2022.1

SPRING SUMMER / NEW ARRIVALS

Discover the new collection



NEW ARRIVALS

SPRING - SUMMER

THE AQUANOVA BATH ESSENTIALS ARE THE FOUNDATION OF OUR BRAND. A STRONG COLLECTION INSPIRED BY OUR CLASSICS. BESTSELLERS WHICH MOVE WITH THE SEASONS. LOOKS WHICH ADAPT EFFORTLESSLY THANKS TO ITS MIX & MATCH PRINCIPLE AND TIMELESS CHARACTER. A PROMISE THAT WILL EARN YOU THE LOYALTY OF YOUR CUSTOMERS THROUGHOUT EVERY SEASON.

BATH MATS >

AXEL

Bath mat	60x60 cm	AXEBMB
Bath mat	60x100 cm	AXEBMM
Bath mat	70x120 cm	AXEBML



136 Nougat



155 Camel

BELA

Bath mat	60x60 cm	BELBMB
Bath mat	60x60 cm	BELBMW
Bath mat	60x100 cm	BELBMM
Bath mat	70x120 cm	BELBML



15 Beige



87 Dusty Pink



98 Dark Grey



09 Black

LONDON

Bath mat	60x60 cm	LONBMB
Bath mat	60x100 cm	LONBMM
Bath mat	70x120 cm	LONBML



806 Birch



136 Nougat



155 Camel

MUSA

Bath mat	60x60 cm	MUSBMB
Bath mat	60x100 cm	MUSBMM
Bath mat	70x120 cm	MUSBML
Bath mat	cm ø 80 cm	MUSBMR



155 Camel

LOA

Bath mat	60x60 cm	LOABMB
Bath mat	60x60 cm	LOABMW
Bath mat	60x100 cm	LOABMM
Bath mat	70x120 cm	LOABML



16 Linen



293 Thyme



87 Dusty Pink



96 Graphite



09 Black



TOWELS >

LONDON

Washcloth	16x22 cm	LONTWW
Guest towel	30x50 cm	LONTWG
Towel	55x100 cm	LONTWS
Bath towel	70x130 cm	LONTWL
Bath towel	100x150 cm	LONTWX



806 Birch



136 Nougat



155 Camel





ORGANIZERS >

CYRA

Wall mount tray 32,1x8,7x6 cm CYRWTM

Included suspension bracket, 2 screws (stainless steel) and 2 Fischer plugs

Match your accessories.
See page 36 for the Khana series



09 Black

ACCESSORIES >

KHANA

Soap dispenser Small 6,5x6,5x16,1 cm KHADIS
 Soap dispenser Medium 6x9x14,5 cm KHADIM
 Toothbrush holder 6,5x6,5x11,6 cm KHATUM
 Toilet brush holder 9,7x11,3x38,4 cm KHABHW

KHABHW: Included 2 screws (stainless steel) and 2 Fischer plugs



09 Black



Mountable

MOON

Soap dispenser	11x5x15 cm	MOODIS
Toothbrush holder	7,5x7,5x10 cm	MOOTUM
Soap dish	9x13,5x2 cm	MOOSDI
Toilet brush holder	10x10x38,5 cm	MOOBHR
Tissue holder	26,5x13x8 cm	MOOTIL
Tray	21,5x14x3,5 cm	MOOTRA



16 Linen

NERO

Soap dispenser ø 9x13 cm NERDIM
 Toothbrush holder ø 6x13 cm NERTUM
 Soap dish ø 12x6 cm NERSDI
 Toilet brush holder ø 9,5x38,5 cm NERBHR
 Spare toilet paper holder ø 12x47 cm NERRLH
 Tissue holder 27,3x14,4x9,2 cm NERTIL
 Tray 30x23x1 cm NERTRA
 Mirror 10x17x30 cm NERMIR



195 Alba

UGO

Soap dispenser 13x10x14 cm UGODIS
 Toothbrush holder 7,5x14x10 cm UGOTUM
 Soap dish 12x10x3 cm UGOSDI
 Beauty box 11,5x9x9,5 cm UGOCOS
 Toilet brush holder ø 10x38,5 cm UGOBHR
 Tissue holder 26,3x13,4x8,4 cm UGOTIL
 Tray 26x13x3 cm UGOTRA



155 Camel



LAUNDRY BASKETS >

OSMAN

Laundry basket large	ø49x65 cm	OSMLAL
Laundry basket small	ø36x49 cm	OSMLAS



136 Nougat



OSMAN

Storage basket	ø30x30 cm	OSMSBM
----------------	-----------	--------



136 Nougat

RUDON

Laundry basket	ø35x45 cm	RUDLAS
----------------	-----------	--------



125 Moss



09 Black

RENA

Storage basket	38x27x24 cm	RENSBM
Storage basket	24x18x16 cm	RENSBS



806 Birch



STORAGE BASKETS >

LUBIN

Storage basket	40x40x30 cm	LUBSBL
Storage basket	35x27x30 cm	LUBSBM
Storage basket	32x20x15 cm	LUBSBS



582 Sage green

SOAP >

PARIS

Liquid soap Agrumes	500 ml	PARLDM-AGR
Liquid soap Bois De Cèdre	500 ml	PARLDM-BDC
Liquid soap Coriandre	500 ml	PARLDM-COR
Liquid soap Thé Vert	500 ml	PARLDM-TVE
Refill Agrumes	1000 ml	PARSRL-AGR
Refill Bois De Cèdre	1000 ml	PARSRL-BDC
Refill Coriandre	1000 ml	PARSRL-COR
Refill Thé Vert	1000 ml	PARSRL-TVE





BATH MATS

STYLISH AND PRACTICAL

Beautifully designed bath mats. Make your choice from our wide variety of woven, tufted or handcrafted bath mats. Perfect for every bathroom. Learn more about the quality of our essentials on page 98.

**BATH
MATS**_{BELA}

AXE

L
20% cotton
80% polyester
Handloom woven
Hot melt latex backing

pile 20 mm I 1400 gr/m²
mat 30 mm I 2600 gr/m²

Bath mat 60x60 cm	<u>AXEBMB</u>
Bath mat 60x100 cm	<u>AXEBMM</u>
Bath mat 70x120 cm	<u>AXEBML</u>



• **New color:**
136 Nougat
155 Camel



16 Linen **136** Nougat **40** Latte **443** Ochre



8 Dusty pink **284** Umber **15** Camel **116** Willow



12 Moss **22** Pine **96** Graphite



1 Beige **87** Dust Pink **98** Dark Grey **09** Black

BEL

A
100% acrylic
Synthetic latex backing
Table tufted

pile 35 mm I 2300 gr/m²
mat 37 mm I 2600 gr/m²

Bath mat	60x60 cm	<u>BELBMB</u>
Bath mat	60x60 cm	<u>BELBMW</u>
Bath mat	60x100 cm	<u>BELBMM</u>
Bath mat	70x120 cm	<u>BELBML</u>



• **New product**

**BATH
MATS**_{KEMEN}

JUR

A
100% polyester
Recycled PET
Handloom woven

pile 10 mm I 2600 gr/m²
mat 20 mm I 3000 gr/m²

Bath mat 60x60 cm	<u>JURBMB</u>
Bath mat 60x100 cm	<u>JURBMM</u>
Bath mat 70x120 cm	<u>JURBML</u>



RECYCLED PET

KEME

N
14% cotton
86% polyester
Handloom woven
Latex spray backing

pile 55 mm I 3260 gr/m²
mat 59 mm I 3800 gr/m²

Bath mat 60x60 cm	<u>KEMBMB</u>
Bath mat 60x100 cm	<u>KEMBMM</u>
Bath mat 70x120 cm	<u>KEMBML</u>
Bath mat 80x160 cm	<u>KEMBMX</u>



10 Ivor **9** Grey **90** Stone **98** Dark grey



14 Sand **05** Taup **443** Ochre **293** Thyme



269 Forest **95** Silver grey **98** Dark grey **09** Black

LONDO

N

100% combed Egyptian cotton
Dobby woven
Clear silicon dots backing

mat 11 mm I 1200 gr/m²

Bath mat 60x60 cm
Bath mat 60x100 cm
Bath mat 70x120 cm

LONBMB
LONBMM
LONBML



• New color:
806 Birch
136 Nougat
155 Camel



739 Ocean



8 Dusty pink
7



293 Thyme



193 Apricot



269 Forest



203 Brandy



70 Cedar



284 Umber



12 Moss



15 Camel
5



43 White



10 Ivory



806 Birch



16 Linen



136 Nougat



40 Latte
1



443 Ochre



369 Aquatic



9 Cool grey
1



96 Graphite



09 Black

LO

A

100% Polyamide
Natural latex (Biodegradable).

pile 19 mm I 1550 gr/m²
mat 23 mm I 2600 gr/m²

Bath mat 60x60 cm
Bath mat 60x60 cm
Bath mat 60x100 cm
Bath mat 70x120 cm

LOABMB
LOABMW
LOABMM
LOABML



• New product



16 Linen



293 Thyme



87 Dusty Pink



96 Graphite



09 Black

MAK

S

70% cotton
30% polypropylene
Handcrafted

mat 20 mm I 3000 gr/m²

Bath mat 60x60 cm
Bath mat 60x100 cm
Bath mat 70x120 cm

MAKBMB
MAKBMM
MAKBML



10 Ivory
y.



0 Taupe
5 e



9 Silver grey
5



98 Dark grey

MUS

A

100% polyester
Basket latex backing
Table top tufted

pile 37 mm I 2300 gr/m²
mat 43 mm I 2600 gr/m²

Bath mat 60x60 cm MUSBMB
Bath mat 60x100 cm MUSBMM
Bath mat 70x120 cm MUSBML
Bath mat ø 80 cm MUSBMR



• New color:
[155 Camel](#)



PE

R

100% GOTS cotton
Machine woven

mat 12 mm I 1500 gr/m²

Bath mat 60x100 cm PERBMM



ORGANIC



ROCC

A

26% cotton
74% polyester
Handcrafted

pile 30 mm I 2350 gr/m²
mat 50 mm I 3525 gr/m²

Bath mat 60x60 cm ROCBMB
Bath mat 60x100 cm ROCBMM
Bath mat 70x120 cm ROCBML





BATH TOWELS

WRAP YOURSELF IN SOFTNESS

Pleasant to use and pretty to look at. Luxurious and super soft or sporty and slightly rougher? You will find towels, guest towels and wash cloths in several high qualities.

BATH TOWELS

LONDON

LONDON

100% combed Egyptian cotton
Dobby woven
Long side double stitched

600 gr/m²

Washcloth 16x22 cm	LONTWW
Guest towel 30x50 cm	LONTWG
Towel 55x100 cm	LONTWS
Bath towel 70x130 cm	LONTWL
Bath towel 100x150 cm	LONTWX



• New color:
806 Birch
136 Nougat
155 Camel



43 White



10 Ivory



87 Dusty pink



806 Birch



16 Linen



136 Nougat



401 Latte



443 Ochre



193 Apricot



203 Brandy



284 Umber



155 Camel



293 Thyme



269 Forest



702 Cedar



125 Moss



739 Ocean



369 Aquatic



91 Cool grey



96 Graphite



09 Black

MILAN

100% American Pima cotton
Dobby woven
Long side double stitched

600 gr/m²

Washcloth 16x22 cm	MILTWW
Towel 55x100 cm	MILTWS
Bath towel 70x140 cm	MILTWL



15 Beige



87 Dusty pink



293 Thyme



804 Cinnamon



269 Forest



98 Dark grey

OSLO

100% cotton
Dobby woven

GOTS
Dobby

500 gr/m²

Washcloth	16x22 cm	OSLTWW
Guest towel	30x50 cm	OSLTWG
Towel	55x100 cm	OSLTWS
Bath towel	70x130 cm	OSLTWL
Bath towel	100x150 cm	OSLTWX



Organic
Certified by
Control Union
CU 1005907

ORGANIC COTTON



813 Sedum



299 Ginger



804 Cinnamon



116 Willow



223 Pine



633 Caviar

BATH TOWELS

MILAN - OSLO



BATHROBES

RELAX AND ENJOY

Whether you like a slim or regular fit, a soft or a rougher touch; take a look and choose your style.

EINAR

Inside: 60% bamboo 40% cotton
 Outside: 100% polyester fleece

330 gr/m2

Bathrobe Small	EINBGS
Bathrobe Medium	EINBGM
Bathrobe Large	EINBGL
BathrobeExtra large	EINBGX



A LENGTH small 114cm / medium 116cm / large 118cm / extra large 120cm
B WAIST small 120cm / medium 126cm / large 132cm / extra large 138cm
C SLEEVE LENGTH small 62cm / medium 64cm / large 66cm / extra large 68cm

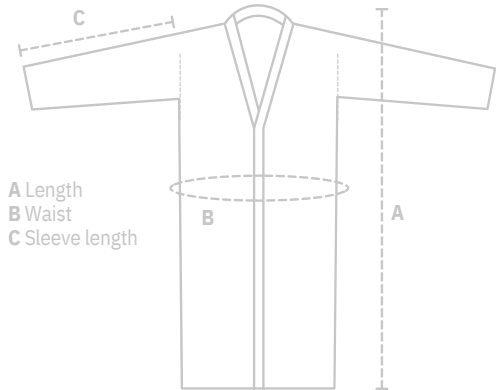

A Length
 B Waist
 C Sleeve length



10 Ivory



443 Ochre



96 Graphite



269 Forest

VIGGO

100% cotton piqué GOTS Waffle

280 gr/m²

Bathrobe	Small	VIGBGS
Bathrobe	Medium	VIGBG
Bathrobe	Large	M
Bathrobe	Extra large	VIGBGL
Bathrobe		VIGBGX



A LENGTH small 112cm / medium 114cm / large 116cm / extra large 118cm
B WAIST small 120cm / medium 126cm / large 132cm / extra large 138cm
C SLEEVE LENGTH small 62cm / medium 66cm / large 67cm / extra large 68cm



Organic Certified by Control Union CU 1005907

ORGANIC COTTON

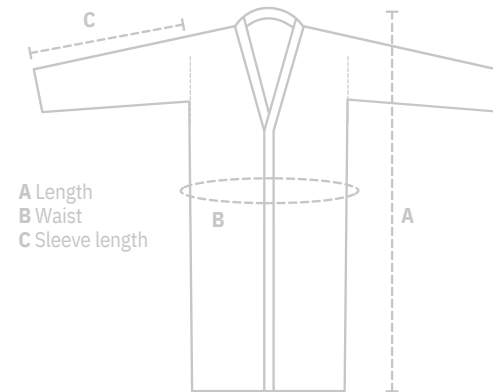

A Length
 B Waist
 C Sleeve length



43 White



87 Dusty pink



98 Dark grey



62 Mist green



BATHROOM ACCESSORIES

ACCESSORIZE YOUR BATHROOM

You will be surprised by the variety of designs, materials and colors that we offer within our collection of bathroom accessories.

CONOR

Natural stone
Handcrafted
Stainless steel #304

1. Toothbrush holder	9x8,5x12 cm	CONTUM
2. Soap dish	10x10x3 cm	CONSDI
3. Soap dispenser	7,5x7,5x20,5 cm	CONDIS
4. Beauty box	8,5x8,5x10,5 cm	CONCOS

5. Toilet brush holder	11,5x11,5x36,5 cm	CONBHR
6. Spare toilet paper holder	ø 13x47 cm	CONRLH
7. Bowl	ø 25x7 cm	CONBOW
8. Tray	35x15x3 cm	CONTRA
9. Tray round	ø 30x3 cm	CONTRR
10. Tray square	30x30x3 cm	CONTRS
11..Tissue holder large	25,5x13x7,5 cm	CONTIL

UNIQUE
PIECE
HAND
CRAFTED



15 Beige

FORTE

Stoneware
Stainless steel #304
EVA anti-slip bottom

1. Toothbrush holder	ø 7x10,5 cm	FORTUM
2. Soap dish	ø 12x2,5 cm	FORSDI
3. Soap dispenser small	ø 7x16,5 cm	FORDIS
4. Soap dispenser medium	ø 6x20 cm	FORDIM
5. Toilet brush holder	ø 10x38,5 cm	FORBHR



HAMMA

M

Natural stone
Handcrafted
Stainless steel #304

1. Toothbrush holder	7x7x10,5 cm	HAMTUM
2. Soap dish	10x10x3 cm	HAMSDI
3. Soap dispenser small	6x6x20,5 cm	HAMDIS
4. Soap dispenser medium	10x6x17,5 cm	HAMDIM
5. Toilet brush holder	9,5x9,5x39 cm	HAMBHR
6. Spare toilet paper holder	12x12x47 cm	HAMRLH

7. Cotton pad holder	ø 8x21,5 cm	HAMCPH
8. Reed diffuser holder	ø 9x17 cm	HAMDFM
9. Guest towel holder	7,5x17x24,5 cm	HAMGTH
10. Tissue holder large	35x15x3 cm	HAMTIL
11. Bowl	25,5x13x7,5 cm	HAMBOW
12. Tray	ø 25x7 cm	HAMTRA
13. Tray round	ø 30x3 cm	HAMTRR
14. Tray square	30x30x3 cm	HAMTRS
15. Beauty box round	ø 9x11 cm	HAMCHS
16. Bowl with lid	ø 17x8 cm	HAMSHM

UNIQUE
PIECE
HAND
CRAFTED



KHANA

Polyresin
Stainless steel #304
Matte coated

KHABHW: Included 2 screws (stainless steel) and 2 Fischer plugs

Combinable with Cyra wall tray (p. 82)

• New product

- | | | |
|---|--------------------------------------|--------|
| 1 | Soap dispenser Small 6,5x6,5x16,1 cm | KHADIS |
| . | Soap dispenser Medium 6x9x14,5 cm | KHADIM |
| 2 | Toothbrush holder 6,5x6,5x11,6 cm | KHATUM |
| . | Toilet brush holder 9,7x11,3x38,4 cm | KHABHW |
| 3 | | |
| . | | |
| 4 | | |
| . | | |



1. 140 ml
2cc pump

09 Black



2. 390 ml
2cc pump



3



4. Mountable

LUXOR

Natural stone
Handcrafted
Stainless steel #304

UNIQUE
PIECE
HAND
CRAFTED

- | | | | |
|---|---------------------------|----------------|--------|
| 1 | Toothbrush holder | ø 7,5x10 cm | LUXTUM |
| . | Soap dish | ø 12x4 cm | LUXSDI |
| 2 | Soap dispenser | ø 12x13 cm | LUXDIS |
| . | Toilet brush holder | ø 11x36 cm | LUXBHR |
| 3 | Spare toilet paper holder | ø 12x47 cm | LUXRLH |
| . | Bowl | ø 25x7 cm | LUXBOW |
| 4 | Tissue holder large | 25,5x13x7,5 cm | LUXTIL |
| 5 | | | |
| . | | | |
| 6 | | | |
| . | | | |
| 7 | | | |
| . | | | |



1



2



3 230 ml
2cc pump



4



5



6

14 Cream



7

LIV

100% polyester felt
Recycled PET

Tissue holder 24x13x13 cm LIVTIL

RECYCLED PET



401 Latte



09 Black

MOON

Polymarble
Zinc alloy
Stainless steel #304
Mirror: powder coated metal

• New color: 16 Linen

- | | | |
|------------------------|-----------------|--------|
| 1. Toothbrush holder | 7,5x7,5x10 cm | MOOTUM |
| 2. Soap dish | 9x13,5x2 cm | MOOSDI |
| 3. Soap dispenser | 11x5x15 cm | MOODIS |
| 4. Beauty box | 7,5x7,5x10,5 cm | MOOCOS |
| 5. Toilet brush holder | 10x10x38,5 cm | MOOBHR |
| 6. Mirror | 14x17x34 cm | MOOMIR |
| 7. Tray | 21,5x14x3,5 cm | MOOTRA |
| 8. Tissue holder large | 26,5x13x8 cm | MOOTIL |



1



2



3 370 ml
2cc pump



4



5



6 2x magnifying



7

43 White



8

MOON

Polymarble
Zinc alloy
Stainless steel #304
Mirror: powder coated metal

• New color: 16 Linen

- 1.Toothbrush holder
- 2.Soap dish
- 3.Soap dispenser
- 4.Beauty box
- 5.Toilet brush holder
6. Mirror
7. Tray
- 8.Tissue holder large

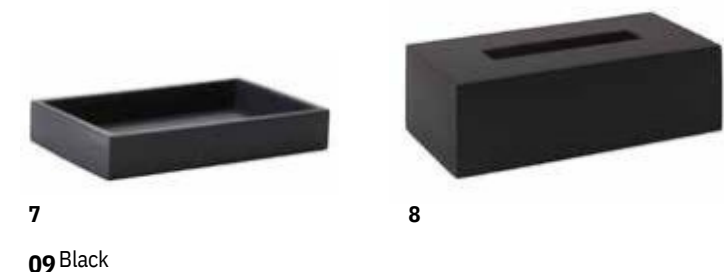

• 16 Linen

NERO

Natural stone
Handcrafted
Stainless steel #304
Inner case toilet brush holder: recycled PP
Metal

• New color: 195 Alba



1.Toothbrush holder	ø 6x13 cm	NERTUM
2. Soap dish	ø 12x6 cm	NERSDI
3.Soap dispenser	ø 9x13 cm	NERDIM
4.Toilet brush holder	ø 9,5x38,5 cm	NERBHR
5. Mirror	10x17x30 cm	NERMIR
6. Tray	30x23x1 cm	NERTRA
7.Tissue holder	27,3x14,4x9,2 cm	NERTIL
8.Spare toilet paper holder	ø 12x47 cm	NERRLH



• 09 Nero

BATHROOM ACCESSORIES

NERO

NERO

Natural stone
Handcrafted
Stainless steel #304
Inner case toilet brush holder: recycled PP
Metal

• New color: 195 Alba

UNIQUE
PIECE
HAND
CRAFTED

1. Toothbrush holder	ø 6x13 cm	NERTUM
2. Soap dish	ø 12x6 cm	NERSDI
3. Soap dispenser	ø 9x13 cm	NERDIM
4. Toilet brush holder	ø 9,5x38,5 cm	NERBHR
5. Mirror	10x17x30 cm	NERMIR
6. Tray	30x23x1 cm	NERTRA
7. Tissue holder	27,3x14,4x9,2 cm	NERTIL
8. Spare toilet paper holder	ø 12x47 cm	NERRLH



• 195Alba



ONA

Polyresin with rubber coating
 Stainless steel #304
 Glass

1	Soap dispenser medium	9,5x9,5x12 cm	ONADIM
2	Soap dispenser large	6,5x6,5x17 cm	ONADIL
3	Soap dish	10x10x3 cm	ONASDI
4	Toothbrush holder	6,5x6,5x11,5 cm	ONATBH
5	Toilet brush holder	10x10x38 cm	ONABHR
6	Spare toilet paper holder	12x12x47,5 cm	ONARLH
7	Tissue holder	26x12x7,5 cm	ONATIL
8	Pedal bin 3L	ø 17-22x34 cm	ONABIS

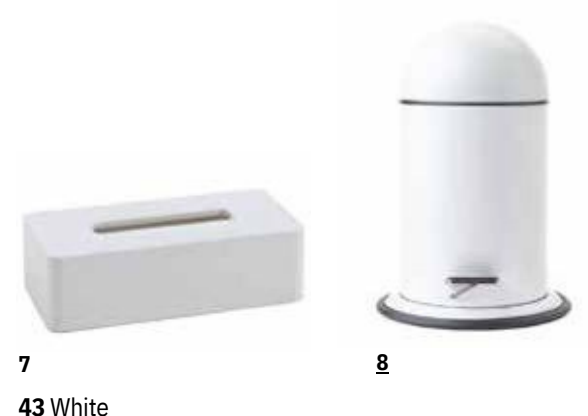

OPAC

O

Stoneware
With rubber coating
Stainless steel #304
Zinc Alloy

1	Toothbrush holder	ø 7,5x10 cm	OPATUM
2	Soap dish	ø 12x3 cm	OPASDI
3	Soap dispenser	ø 10,5x13,5 cm	OPADIS
4	Toilet brush holder	cm ø 10,5x39 cm	OPABHR



1
29 Sorbet



2



3 450 ml
2cc pump



4



1
0 Black
9



2



3 450 ml
2cc pump



4

OSCA

R

Earthenware
Beech wood
Stainless steel #304
Zinc alloy

Spare toilet paper holder :
Beech wood
Powder coated metal

1	Toothbrush holder	7x7x11 cm	OSCTUM
2	Soap dish	13x9x2,5 cm	OSCDI
3	Soap dispenser	7,5x7,5x17,5 cm	OSCDIS
4	Toilet brush holder	cm	OSCBHR
5	Spare toilet paper holder	10x10x39,5 cm	OSCRXH



1
4 White
3



2



3 250 ml
2cc pump



4



5



1
0 Black
9



2



3 250 ml
2cc pump



4



5

UGO

Stoneware
Handcrafted
Reactive glaze effect
Stainless steel #304

UNIQUE
PIECE
HAND
CRAFTED

• New color:
155 Camel

1. Toothbrush holder	7,5x14x10 cm	UGOTUM
2. Soap dish	12x10x3 cm	UGOSDI
3. Soap dispenser	13x10x14 cm	UGODIS
4. Beauty box	11,5x9x9,5 cm	UGOCOS
5. Toilet brush holder	ø 10x38,5 cm	UGOBHR
6. Tissue holder	26,3x13,4x8,4 cm	UGOTIL
7. Tray	26x13x3 cm	UGOTRA
8. Reed diffuser holder	ø 9x17 cm	UGODFM
9. Bowl with lid	ø 17x8 cm	UGOSHM



1
299 Ginger



2



3 500 ml
2cc pump



4



5



1



2



3 500 ml
2cc pump



4



5



6

994 Black olive



7



1



2



3 500 ml
2cc pump



4



5



6

269 Forest



7



8 Sticks & liquid
not included



9



1



2



3 500 ml
2cc pump



4



5



6

854 Vintage bronze



7



8 Sticks & liquid
not included



9

UGO

Stoneware
Handcrafted
Reactive glaze effect
Stainless steel #304

1	Toothbrush holder	7,5x14x10 cm	UGOTUM
.	Soap dish	12x10x3 cm	UGOSDI
2	Soap dispenser	13x10x14 cm	UGODIS
.	Beauty box	11,5x9x9,5 cm	UGOCOS
3	Toilet brush holder	ø 10x38,5 cm	UGOBHR
.	Tissue holder	26,3x13,4x8,4 cm	UGOTIL
4	Tray	26x13x3 cm	UGOTRA

5
6
7

UNIQUE
PIECE
HAND
CRAFTED

• New color:
155 Camel



1



2



3 500 ml
2cc pump



4



5



6

• 155 Camel



7





MIRRORS

LOOK WHO'S THERE!

Mirror, mirror on the wall, the shelf, the sink or anywhere else in the bathroom. Decorative but also very useful when applying makeup.

MIRRORS

BEAU - MOON

BEAU

Metal
Powder coated

Mirror ø 20x32 cm BEAMIR



43 White
3x magnifying



09 Black
3x magnifying

MOON

Metal
Powder coated

Mirror 14x17x34 cm MOOMIR



43 White
2x magnifying



09 Black
2x magnifying

MIRRORS

NERO - THYMO

NERO

Glass
Metal
Natural stone

Mirrorø 17x30 cm NERMIR

• New color: 195 Alba



195Alba
3x magnifying



09 Black
3x magnifying

THYMO

Metal
Matt paint coating
Faux leather belt 80 cm
With wall mount

Mirrorø 47x3,5 cm THYMIR



09 Black



WASTE BINS

CLEAN UP

Big or small, shiny or matt, pastel or bright? Our waste bins are wonderful, practical and match any color concept.

LURA

Lid & bottom: stainless steel #304
Body: stainless steel #430
Inner bucket: polypropylene

3L

Pedal binø 17-22x34 cm

LURBIS



1 Copper
3

ON

A

Lid & bottom: metal
Inner bucket: polypropylene

3L

Pedal binø 17-22x34 cm

ONABI
S



43 White



85 Blush



29 Sorbet



30 Honey



93 Greige



804 Cinnamon



269 Forest



99 Concrete



98 Dark grey



09 Black

BATH & SHOWER BASICS

VERY USEFUL

Just the extra comfort and help that you need.

ARVID

1: 30% metal 70% silicone
 2: 90% metal 10% silicone
 Matte coated
 With wall mount

Shower wiper 30x25x3,5 cm	ARVBWM
Bathroom wiper large 125x26x3 cm	ARVBWL



1

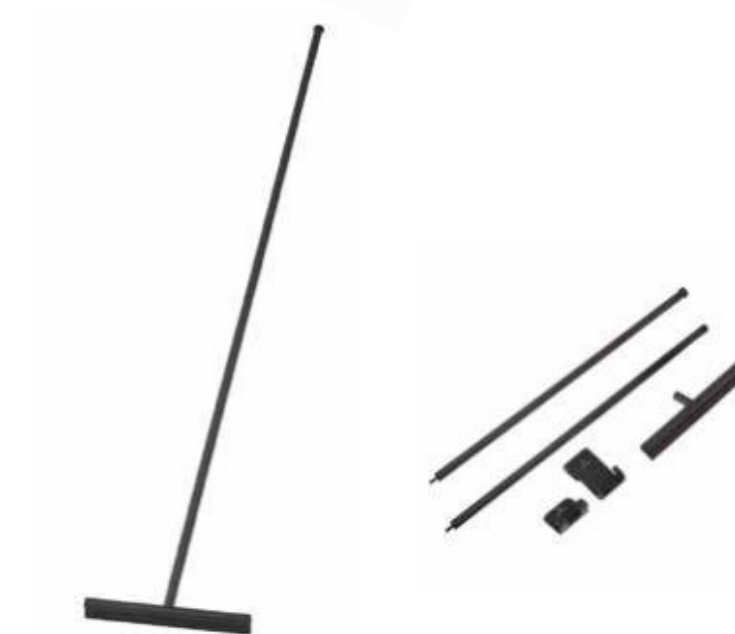

2

09 Black

BALANZA

Tempered glass
 Steel
 Digital

Scale	30x30x3 cm	BALSCA
-------	------------	--------



09 Black
 Max. 180kg



LAUNDRY BASKETS

WASH, DRY, FOLD, REPEAT

Go for a very simple look, or choose a real eyecatcher.

LAUNDRY BASKETS

AMY - ARIAN

AM

Y

100% polyester felt
Fir wood handles: 5 cm
Thickness felt: 4mm

75L

Laundry basket 40x60 cm

AMYLAL

Not washable



9 Silver grey
5



98 Dark grey

ARIA

N

Outer: 50% cotton - 50% polyester
Inside: 100% polyester
PU handles - corners
2 compartments

75L

Laundry basket 50x25x60 cm

ARILAL

Not washable



58 Sage green
2



98 Dark grey

CIN

O

100% rattan
Rattan & leather handles: 4 cm
Canvas liner
Woven
Handcrafted

58L

Laundry basket 35x60 cm

CINLAL



299 Ginger



09 Black

DAL

I

10-11-98: 100% terylene
05: 50% cotton 50% terylene
Frame: paulownia wood

103L

Laundry basket 46x37x61 cm

DALLAL

Not washable



10 Ivory
1



1 Flax
1



0 Taupe
5 e



98 Dark grey

LAUNDRY BASKETS

CINO - DALI

LAUNDRY BASKETS

DIX -
EDRIS

DI
X

100% polyester felt
Recycled PET
Bamboo handle
Thickness felt: 4mm

66L

Laundry basket 34x34x57,5 cm DIXLAL

Not washable LED PET



1 5 Beige



09 Black

EDRI
S

Faux leather

42L

Laundry basket ø 30x62 EDRLAS
cm



43 White



98 Dark grey



09 Black

EVOR

A

11-98: 100% terylene
92: 50% cotton 50% terylene
Liner: 30% cotton 70% terylene
Support sticks

112L

Laundry basket 40x40x70 cm EVOLAL



Removable & washable liner



1 1 Flax



9 2 Grey



98 Dark grey

LAUNDRY BASKETS

EVOR
A

LAUNDRY BASKETS

JAD

A

JAD

A

60% polyester
 30% EVA
 3% metal
 5% fiberboard
 Metal & faux leather handles: 8 cm
 2 compartments

85L

Laundry basket 50x30x60 cm

JADLA
L

Not washable



10 Ivor
y.



1 Beige
5



0 Brown
1



9 Silver grey
5



09 Black

LAUNDRY BASKETS

LUBI

N

LUBI

N

15: 50% cotton 50% polyester
 95-09: 100% terylene
 Leather handles: 5 cm
 Leather corners
 Liner: 30% cotton 70%
 terylene Support sticks

113L

Laundry basket 50x35x65 cm LUBLAL

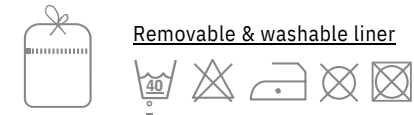

1 Beige
5



9 Silver grey
5



09 Black

LAUNDRY BASKETS

LUZ - NORT

LUZ

100% polyester felt
Recycled PET
Bamboo handle
Thickness felt: 4mm

98L

Laundry basket 40x40x60 cm

LUZLAL

Not washable

RECYCLED PET



15 Beige



09 Black

NORT

60% cotton
40% polyester
Faux leather handles: 7 cm
100% polyester liner
No support sticks needed

76L

Laundry basket ø 42x55 cm

NORLAL

Not washable



98 Dark grey



LAUNDRY BASKETS

OSMAN - RUDON

OSMAN

35% cotton
65% polyester
No support sticks needed

Large: 100L
Small: 45L

Laundry basket large ø 49x65 cm
Laundry basket small ø 36x49 cm

OSMLAL
OSMLAS

Not washable

• New product



136 Nougat



RUDON

50% cotton
50% polyester
Leather handles: 10 cm
No support sticks needed

43L

Laundry basket ø 35x45 cm

RUDLAS

Not washable

• New colors:
125 Moss
09 Black



15 Beige



92 Grey



125 Moss



09 Black

YORK

60% cotton
40% polyester
Faux leather handles: 7 cm
No support sticks needed
100% polyester liner

76L

Laundry basket ø 42x55 cm

YORLAL

Not washable



582 Sage green



269 Forest

LAUNDRY BASKETS

YORK



STORAGE BASKETS

SMALL BASKETS, BIG SUCCESS

A great way to complement your bathroom. Functional and personal.
These baskets are fit to be seen!

**STORAGE
BASKETS** LIV

**AM
Y**

100% polyester felt
Fir wood handle: 5 cm
Thickness felt: 3mm

1.Storage basket medium	ø 35x30 cm	AMYSBM 33L
2.Storage basket small	ø 33x12,5 cm	AMYSBS 7L

Not washable



1
9 Silver grey.
5



2



1
98 Dark grey.



2

**DI
X**

100% polyester felt
Recycled PET
Bamboo handle

28L

Storage basket	34x25,5x32 cm	DIXSB M
----------------	---------------	---------

Not washable **RECYCLED PET**



1 Beige
5



09 Black

**LI
V**

100% polyester felt
Recycled PET
Thickness felt: 3mm
1 wooden hook, plug and screw included

Storage basket	17x17x17 cm	LIVSB S	4L
----------------	-------------	---------	----

Not washable **RECYCLED PET**



40 Latte
1



09 Black

**STORAGE
BASKETS**

LUBI
N

**LUBI
N**

15 - 582: 50% cotton 50% terylene 95: 100% terylene
Leather handles: 7 cm
Leather corners
Non woven liner
Support sticks

Not washable

• New color: 582 Sage green

1	Storage basket large	40x40x30 cm	LUBSBL	48L
2	Storage basket medium	35x27x30 cm	LUBSBM	28L
3	Storage basket small	32x20x15 cm	LUBSBS	9L



1
1 Beige
5



2



3



1
9 Silver grey.
5



2



3



1
58 Sage green
2



2



3

STORAGE BASKETS

LUZ - OSMAN

LUZ

100% polyester felt
Recycled PET
Bamboo handle
Thickness felt: 4mm

30L

Storage basket 40x25x30 cm LUZSBM

Not washable

RECYCLED PET



15 Beige



09 Black

OSMAN

35% cotton
65% polyester
No support sticks needed

Storage basket medium ø30x30 cm OSMSBS 18L

• New product



136 Nougat

STORAGE BASKETS

RENA

RENA

70% cotton
30% polyester

1.Storage basket medium	38x27x24 cm	RENSBM	27 L
2.Storage basket small	24x18x16 cm	RENSBS	4L

• New color:
806 Birch



1
10 Ivory



2



1
806 Birch



2



1
813 Sedum



2



1
804 Cinnamon



2



1
16 Linen



2



1
702 Cedar



2



1
223 Pine



2



1
09 Black



2

YORK

60% cotton 40% polyester
Faux leather handles: 7 cm
Non woven liner

15L

Storage basket 36x26x17 cm

YORSBM

Not washable



582 Sage green



269 Forest



BATHROOM ORGANIZERS

PRACTICAL WITH CLASS

Timeless essentials for every bathroom, matching the complete concept.

BATHROOM ORGANIZERS

EPIC

CYR

A
Stainless Steel
Powder coated
Water resistant

Wall mount tray 32,1x8,7x6 cm CYRWTM

Included: 2 screws (stainless steel) and fischer plugs

• New product



Match your accessories.
See page 36 for the Khana series



EPI

C
Metal
Matte coated

Towel holder	43x24x81 cm	EPITL H
--------------	-------------	---------



BATHROOM ORGANIZERS

ICO
N

ICO

N
Metal
Rubber feet

1 Towel holder	44,5x35,5x86 cm	ICOTL H
2 Towel ladder	45x3x175 cm	ICOTLL

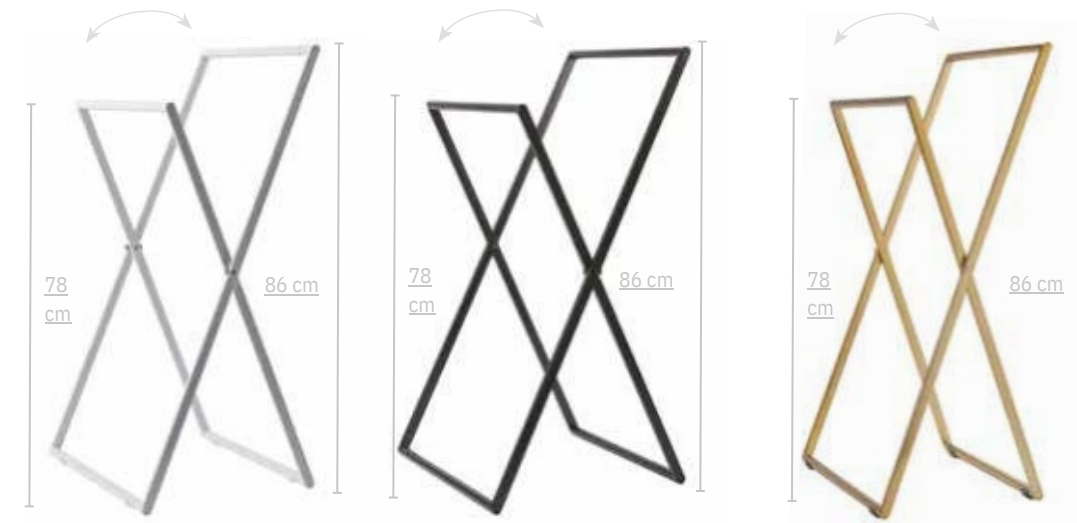

1
43 White
Matte coated

09 Black
Matte coated

12 Gold
Electroplated

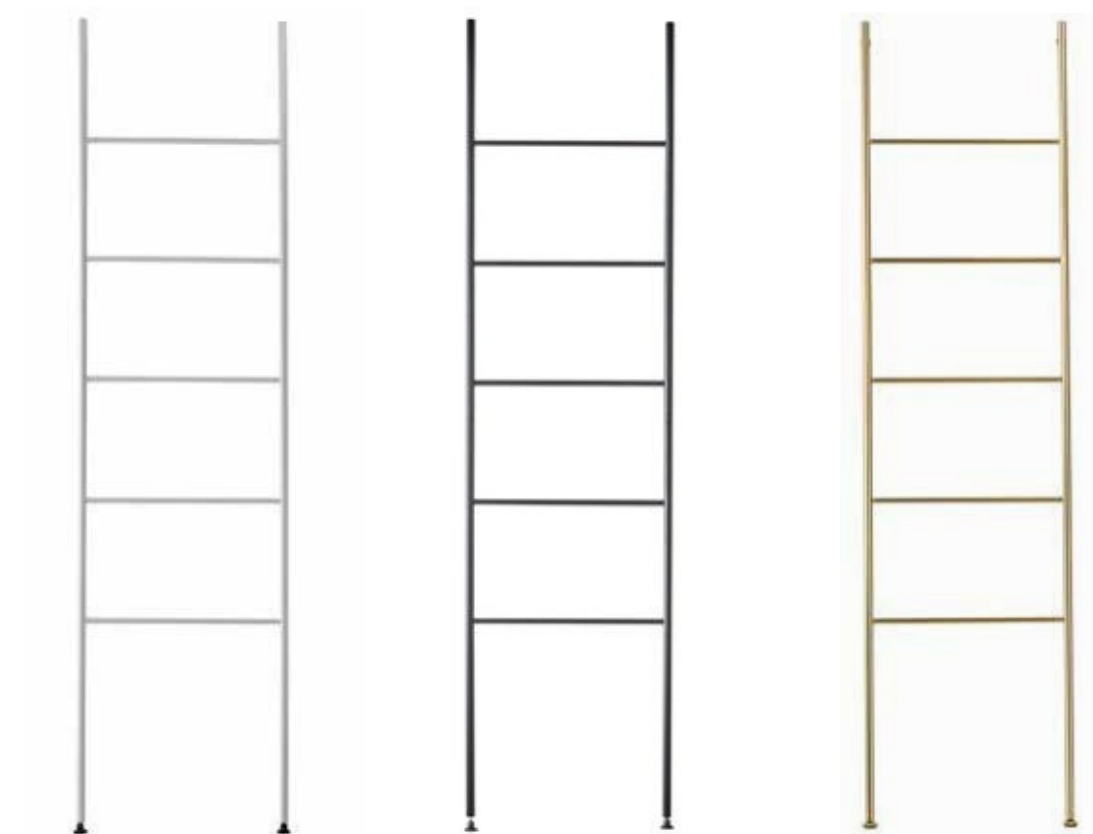

2
43 White
Matte coated

09 Black
Matte coated

12 Gold
Electroplated

BATHROOM ORGANIZERS

LIV - MINK

LIV

100% polyester felt
Recycled PET
2 wooden hooks, plugs and screws included

Wall organizer 35x6x83 cm LIVWOS

RECYCLED PET



401 Latte

09 Black

MINK

Oak
Lacquered
Handmade
FSC certified

1. Bathroom bench	60x23x45 cm	MINBB
2. Bath bridge	22x80x3 cm	M
3. Towel ladder	42x4x165 cm	MINBR
		M
		MINTLL

UNIQUE
PIECE
HAND
CRAFTED

MADE
IN
BELGIUM



387 Oak

09 Black

BATHROOM ORGANIZERS

OSCAR - YURI

OSCAR

Metal
Powder coated
Beechwood

Spare toilet paper holder 20x15x71,5 cm OSCRXH



43 White

09 Black

YURI

Metal
Rectangular tube

Towel holder 45x20x83 cm YURLH



43 White
Matte coated

09 Black
Matte coated

127 Gold
Electroplated

PESCA

98: Bois de cèdre - peach scrub
443: Gingembre - peach scrub
582: Thé vert - peach scrub

Soap150 gr

PESPL



98 Dark grey



443 Ochre



582 Sage green

SOAP

TAKE YOUR TIME

Spoil yourself with these delicately scented soaps. A pleasure to use and pretty to look at.

PARIS

Liquid soap
 Fragrance from Grasse
 Coprah oil
 Olive oil
 For all skin types
 No use of synthetic surfactants
 100% Vegan
 PET bottle
 Dispenser: ø 8,4 x 14,7 cm
 Refill: ø 8,4 x 22 cm

Liquid soap Agrumes500 ml	PARLDM-AGR
Liquid soap Bois De Cèdre500 ml	PARLDM-BDC
Liquid soap Coriandre500 ml	PARLDM-COR
Liquid soap Thé Vert500 ml	PARLDM-TVE
Refill Agrumes1000 ml	PARSRL-AGR
Refill Bois De Cèdre1000 ml	PARSRL-BDC
Refill Coriandre1000 ml	PARSRL-COR
Refill Thé Vert1000 ml	PARSRL-TVE

• New product



PARSRL-AGR



PARSRL-BDC



PARSRL-COR



PARSRL-TVE



PARLDM-AGR



PARLDM-BDC



PARLDM-COR



PARLDM-TVE

AGR / Agrumes. Bergamot grapefruit and lemon guiding the senses towards vetiver and cedar

BDC / Bois De Cèdre. A relaxing blend of cedar wood patchouli and sandalwood

COR / Coriandre. With its spicy freshness this fragrance takes you on a trip from Asia to the Mediterrean

TVE / Thé Vert. A lemon fragrance with a natural feeling, slightly aromatised with mint and eucalyptus



SYMBOLS

LEARN MORE ABOUT OUR ESSENTIALS. SYMBOLS; WHAT DO THEY MEAN? THE SYMBOLS IN OUR CATALOGUE PROVIDE SPECIFIC INFORMATION TO HELP YOU FIND THE QUALITY THAT YOU ARE LOOKING FOR.

BATH MAT SPECIFICATIONS

These symbols indicate extra information about the bath rug in its whole and the pile of the mat.

This symbol represents the pile of the bath mat. (height and weight) whole and the pile of the mat.

This symbol represents the bath mat in its whole. (height and weight) whole and the pile of the mat.

BATH MAT SPECIFICATIONS

We determined the following symbols to give an indication of the anti-slip level of our bath mats. Please keep in mind this is just an indication. The effectiveness of the anti-slip backing also depends on the type of floor. Regarding the given information, we decline all responsibility for any damage or accidents.

LIGHT ANTI-SLIP - CLEAR SILICON DOTS BACKING
The silicon dots provide anti-slip properties. The backing is wash and UV resistant.



REGULAR ANTI-SLIP - LATEX SPRAY BACKING
The latex spray provides anti-slip properties. The backing is wash resistant.



MEDIUM ANTI-SLIP - (DOUBLE LAYER) LICK ROLL SYNTHETIC LATEX BACKING
The lick roll latex provides anti-slip properties and loop/pile adhesion. The backing is wash and UV resistant.



PREMIUM ANTI-SLIP - EMBOSSED (BASKET STRUCTURE) NATURAL AND SYNTHETIC LATEX BACKING
The embossed latex provides anti-slip properties, loop/pile adhesion and stability. The backing is wash resistant, remains flexible and is durable.



COTTON

The following symbols provide extra information about the type of cotton of our textiles.

ORGANIC COTTON is grown in subtropical countries, using methods and materials that have a low impact on the environment. Grown from non genetically modified plants, without the use of any synthetic agricultural chemicals such as fertilizers or pesticides. Its production also promotes and enhances biodiversity and biological cycles.



EGYPTIAN COTTON is an incredibly soft combed cotton, developed especially for the manufacture of luxurious textiles. This voluminous strong and long staple yarn ensures an extraordinary absorption and a long lasting enjoyment.



GLOBAL TEXTILE CERTIFIED **ORGANIC STANDARD**
This standard stipulates requirements throughout the supply chain for both ecology and labour conditions in textile and apparel manufacturing using organically produced raw materials.



Organic Certified by Control Union CU 1005907

UNIQUE PIECE - HANDCRAFTED

Many of our products are handcrafted and are an example of true craftsmanship.

The nature of this production process means that every piece is slightly different. Variations in color and design can occur, this adds to the overall charm of our products and it makes them unique.

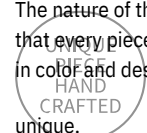

MUST BE WASHED IN A WASHING BAG

Many of our products are handcrafted and are an example of true craftsmanship.

This symbol specifies which bath mats must be washed inside a washing bag to avoid damage of the pile. In order to maintain the quality and the looks of our bath mats, we recommend to wash them according to the care instructions and inside a Lavia washing bag.



WASHING INSTRUCTIONS

TAKE CARE OF YOUR ESSENTIALS. SYMBOLS; WHAT DO THEY MEAN? THE CARE LABELS IN OUR BATH TEXTILES GIVE YOU SPECIAL INSTRUCTIONS TO HELP YOU KEEP YOUR AQUANOVA PRODUCTS LOOKING THEIR BEST.

WASH

The following wash care symbols deal with how your product should be cleaned.

Maximum wash (no bar)
The number within the washtub is the maximum wash temperature.



Medium wash (one bar)
Delicate washing conditions.



Minimum wash (two bars)
Delicate washing conditions.



Hand wash only
Do not machine wash. Wash by hand, maximum temperature 40°C, handle with care.



Not suitable for washing



BLEACH

Most of the Aquanova products are not suitable for bleaching. Therefore you will find the care symbol below on most of our labels.

Do not bleach
The washtub is the maximum wash temperature.

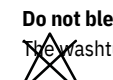

IRON

Once your products are dry, ironing could be necessary. These care symbols explain how your textiles should be ironed.

Cool iron (one dot)
Maximum sole-plate temperature of 110°C
Steam-ironing may be a risk.

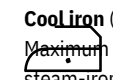

Medium iron (two dots)
Maximum sole-plate temperature of 150°C.



Hot iron (three dots)
Maximum sole-plate temperature of 200°C.



Do not iron
Steaming and steam treatments are not allowed



HEATING

Suitable for underfloor heating
Our bath mats which carry a symbol as shown below are suitable for underfloor heating.



WE'VE PUT TOGETHER A GUIDE FOR YOU TO SEE WHAT ALL THE CARE LABELS REPRESENT. THIS GUIDE EXPLAINS THE SYMBOLS ON YOUR LABELS CONCERNING HOW TO WASH, DRY AND IRON YOUR BATH TEXTILES.

TUMBLE DRY

Once the washing is done, it's just as important to dry your Aquanova product properly. The following wash care symbols explain whether it's safe to use a tumble dryer after washing and if so, which setting is acceptable.

May be tumble dried



Tumble dry low (low heat setting)



Tumble dry normal (normal heat setting)



Do not tumble dry



NATURAL DRYING

In some cases, it's desirable to dry your bath mat naturally. The following care symbols explain the best method to use in order to avoid damaging your product.

Dry flat
Recommended for bath textiles which are easily distorted by vertical hanging.



Hang / Line dry
For textiles which are not distorted by vertical drying or where tumble drying is not recommended.



Drip dry
Recommended for textiles which will withstand distortion and are generally synthetic in nature.



DRY CLEANING

Although we strive to develop products that can be washed at home, some products may be taken care of by a professional. These symbols concern whether your bath textiles should be dry cleaned.

May be dry cleaned



May be dry cleaned
Suitable for dry cleaning using all solvents. (the letter tells the dry cleaner what process is required)



Do not dry clean or remove stains with solvents



FREQUENTLY ASKED QUESTIONS

GENERAL

Are your products sustainable?

Our ambition is to make greener choices every day. The result of this can already be found in a few products. Think of the ‘Global Organic Textile Standard’ label of the Oslo and Per series, the Dix and Sawa baskets made from Bamboo and recycled PET, Jura bath mats made from recycled PET or our other series made from natural materials.

TEXTILE

How do I wash my towels?

The majority of our towels can be washed at 60°. Do you prefer to wash them at 40°? No problem! This way your towels will last even longer and its more environmentally friendly! Ironing and drying instructions vary from product to product. That’s why you should look carefully at the instructions for your product on the care label. It’s best not to let wet textiles dry in the sun. This can cause the colors to fade.

How do I wash my bath mat?

It is important that you put the bath mat in a washing bag. This will protect the bath mat from friction in the drum and keep the mat maintain its look. The bag also catches fluff, so nothing remains in the machine. After washing, you can easily dispose the dirt in the bin. Not every product has the same maintenance instructions. Therefore, look carefully at the instructions of your product on the washing label.

Do not hang your bath mat to dry vertically. This may cause it to deform. Place it rather horizontally on a drying rack. Wet textiles should not be left to dry in the sun. This may cause the colors to fade It is advisable to wash the Bath mats as little as possible. Most mats are so large that they absorb a lot of water in the washing machine. The mat becomes heavy and dries slowly. If you don’t stand on the mat with your shoes on, regular washing may be unnecessary.

My bath mat absorbs little water

Chances are that your mat consists of synthetic material. This has a lower absorption capacity than a natural fabric such as cotton. Part of the water remains on the surface, which means it dries faster than natural fabric. It depends on what you find more pleasant.

My bath mat dries slowly

Chances are that your mat consists of a natural material such as cotton. This has a higher absorption capacity than a synthetic fabric. It takes longer for the mat to dry, but your feet remain drier as the water won’t lay on the surface. It depends on what you find more pleasant.

Are the anti-slip backings suitable for underfloor heating?

Yes they are! All of our bath mats are suitable for underfloor heating.

How do I wash my bathrobe?

Not every product has the same care instructions. Look carefully at the instructions of your product on the care label. Wet textiles should not be allowed to dry in the sun. This can cause the colors to fade.

ACCESSORIES

The pump of my soap dispenser is rusty / soap discolors.

This is not pleasant of course! A possible cause is the pH value of your soap. Stainless steel contains a protective layer. If the pH value is not neutral (7) or the soap is not natural, it can penetrate this layer. Very strong acids (very low pH) and very strong alkalines (very high pH) are extremely corrosive and burn holes through different materials.

Although stainless steel is made to be more resistant to acids, it is less resistant to alkaline substances. In most cases, soap is an alkaline substance. This allows the soap to react with the pump and discolor. It is strongly recommended to choose a pH-neutral soap. This is not only better for the material, but also much healthier for your skin. And that is of course the most important thing.

! Important: in order to maintain the pump, it is best to rinse regularly by pumping in lukewarm water. This way you can prevent the soap from penetrating the protective layer in the long run and rinse away any leftovers immediately. !

The pump is not working as it should. How do I fix this?

If the soap comes out of the pump with difficulty, the pump may be clogged. This can happen when your soap dispenser is not used daily. Solution: in order to maintain the pump, it is best to rinse it regularly by pumping it in lukewarm water. This way you can prevent the soap from penetrating the protective layer in the long run and rinse away any remaining residue.

Leftovers in the pump can also result in soap coming out too quickly. The pressure builds up and pushes the soap out at a higher speed. Another possibility is the fluidity in the soap. A watery soap comes out much faster than a thicker soap.

Can the accessories be put in the dishwasher?

Most of our accessories are not dishwasher proof. Some materials would be able to withstand this, but this does not apply to the anti-slip on the bottom. Therefore, we recommend not putting any Aquanova

accessories in the dishwasher just to be on the safe side. Rinsing by hand in lukewarm water is possible. Clean the pump regularly by pumping it several times in lukewarm water. Then dry the material thoroughly.

How do I maintain the material?

Although the products are suitable for the bathroom, they are not meant to be moist for a longer period of time. In very humid, small rooms, it is recommended to dry the products regularly. Constant exposure to moisture can damage the product. We highly recommend to clean your accessories weekly with a soft damp cloth.

BASKETS

Can I wash my laundry and storage baskets?

Read the washing instructions on the label on the inside. Preferably wash the baskets in a laundry bag. Does the product not carry a washing label? Then it is not suitable for washing. It is best not to let wet textiles dry in the sun. This may cause the colors to fade.

My laundry basket does not stay upright. How do I solve this?

Laundry baskets with a thinner fabric often loose shape when they aren’t filled with laundry. Steaming may help to maintain the shape. Push the basket into the desired shape by hand. Steam the basket to fix the shape as best as possible. Avoid direct contact between the material and the steamer.

ORGANIZERS

How do I maintain my wood products?

Most types of wood shrink or expand in cold or warm temperatures. This does not affect the quality. The wooden bath mats are not suitable for use in the shower. In very humid, small rooms, it is recommended to dry the products regularly. The wood has been given the necessary treatments, but constant exposure to moisture can damage the varnish in the long term. Do not let the product dry in the sun. This may cause it to fade.

How do I take care of my steel products?

The steel products require little or no maintenance. In very humid, small spaces it is recommended to dry the products regularly. Constant exposure to moisture can damage the product.



FOR MORE INSPIRATION VISIT OUR WEBSITE WWW.AQUANOVA.COM
AND DON'T MISS OUR STORIES ON SOCIAL MEDIA

